

Version 2.0
2020

Branding Guidelines

VERBAND DER STUDIERENDEN AN DER ETH ZÜRICH

All of the VSETH's brand features to provide consistency through all design applications.

An Overview

This document communicates the brand and corporate identity of the VSETH. Clearly articulating the mission, values, and persona for the design of all subsequent brand artifacts. The presented topics range from the central aspects of the corporate identity, such as the logo of VSETH or its colors, to aspects that give more of a general orientation, e.g. how to create web-applications or illustrations.

The CI helps the VSETH to form stronger relationships with the students, by connecting the different services & experiences of the VSETH together. At the same time, it is a collection of best practices that avoids many pitfalls inexperienced designers might encounter with visual design.

Consistency is key for the corporate identity system to reflect the VSETH in an effective and positive way. This manual will help to ensure consistency by providing standards and specifications for the use of the VSETH's corporate identity in a variety of situations and different media. It should also provide an insight into the reasoning behind different aspects of the corporate identity and by this allow a consistent usage even in areas that are not covered by the guidelines.



Usage Conditions

The guideline does not change which corporate identity elements are binding for which forms of organisation. This is regulated in the AGO in the guidelines on the VSETH corporate identity. However, the guidelines help to make it easy to implement the requirements of the corporate identity.

The overviews for logo usage and the remaining parts of the guide give you an orientation about the needs to use the VSETH corporate identity. Fields marked as green indicate that it is required to use this component, e.g all sub-organisations are required to use the VSETH logo on its webpage and advertising media.

Moreover, for committees, it is strongly advised to follow the guideline to its full extent for all means of communications, including emails, websites, (web) applications and print media, such as documents or posters. This advice is given since the guide consists of proven concepts that not only ensure a clear and consistent appearance of the VSETH but also consider other aspects like the usability for the target audience.

Besides the mandatory aspects, Fachvereine, Anerkannte Organisationen and Assoziierte Organisationen can apply the presented concepts wherever they like and might use slight adjustments wherever suitable.

Logo Usage

	Website	Correspondence	Advertising Media	Brochures / Newspapers / Protocols	Presentations / Lectures / Film Events	List of Sponsors
Vorstand, Mitarbeiter, Ausschüsse						
Kommission						
Fachvereine						
Anerkannte Organisationen						
Assoziierte Organisationen						

Remaining Part of the Guide

	Specific Byline	Color	Composition	Document Templates / Typography	Web-Applications	Illustration	Photo
Vorstand, Mitarbeiter, Ausschüsse	None						
Kommission	Kommission		strongly advised	strongly advised	strongly advised	strongly advised	strongly advised
Fachvereine	Fachverein						
Anerkannte Organisationen	Organisation						
Assoziierte Organisationen	Organisation						

Table of Contents

Logo Usage	7
Color	27
Composition	33
Typography	53
Iconography	63
Illustration	69
Photography	75

Logo Usage

The use of the logo in different colors and defined clear space, as well as well delineated placement in relation to other content, all help to make it as instantly recognizable as possible at all sizes and in all contexts.

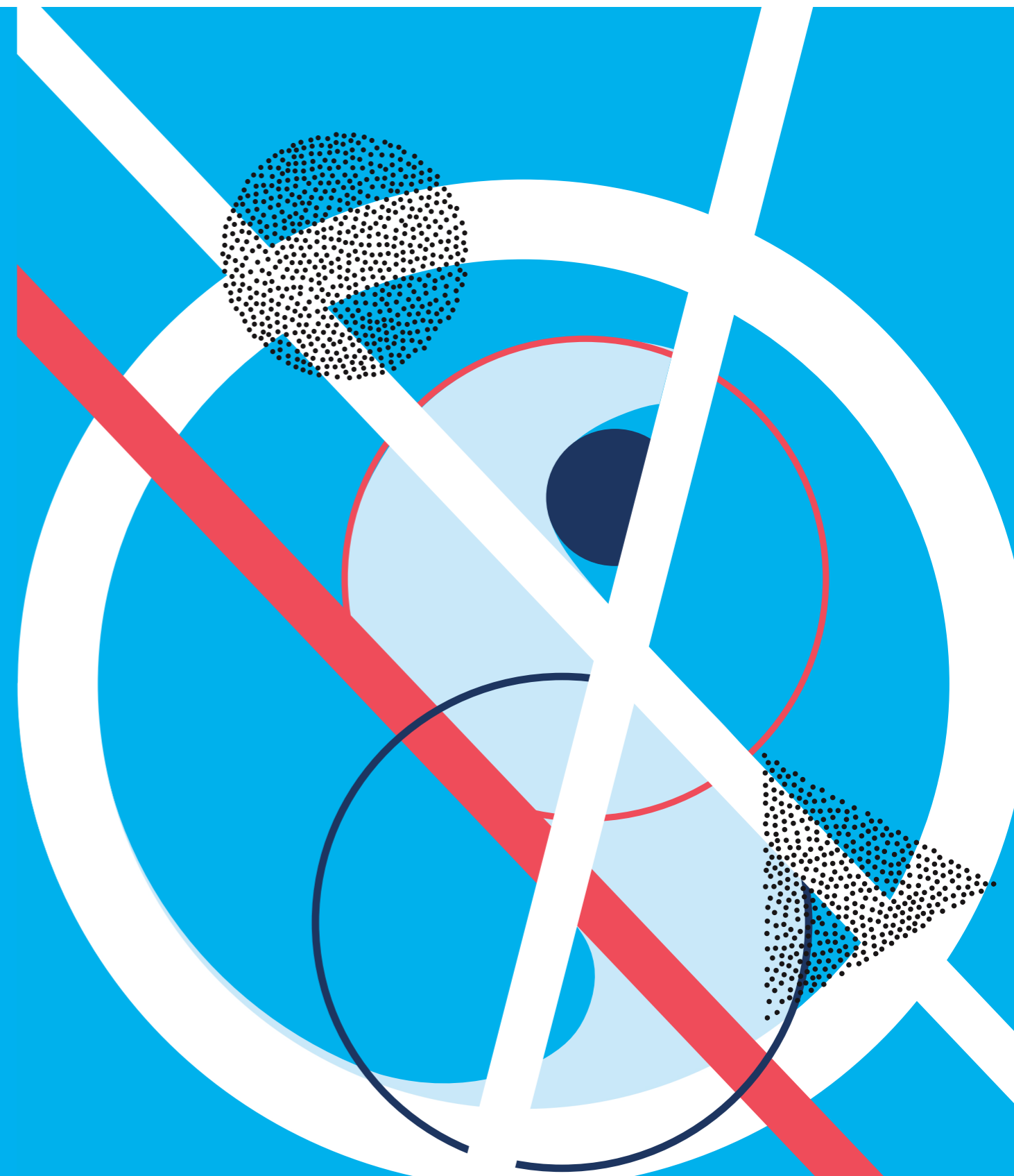

Construction

In our logo, the signet is the focus point. The signet should be recognized as the letter S. The S stands for Students and, thus, the core of the VSETH. Furthermore, the signet is a strong separator between the “v” and “eth”. This makes ETH visibly stand out while still remaining distinct from the branding of ETH Zurich.

The simple definition of the color as one hundred percent cyan allows a broad and flexible usage of the color which simplifies its correct use significantly. The black is one hundred percent K in the CYMK color space.

v  **eth** **Verband der Studierenden an der ETH**

CMYK: **100, 0, 0, 0**
 RGB: **0, 159, 227**
 HEX: **#009FE3**

CMYK: **0, 0, 0, 100**
 RGB: **34, 34, 34**
 HEX: **#222222**

CMYK: **0, 0, 0, 0**
 RGB: **255, 255, 255**
 HEX: **#FFFFFF**

Clear space

An undisturbed clear space allows the logo to stand out of its environment. The top and bottom clear space is the height of the letter “v” from the signet, the left and right clear space is the width of the letter “h”. The byline is half of the letter “h” to the right of the logo.

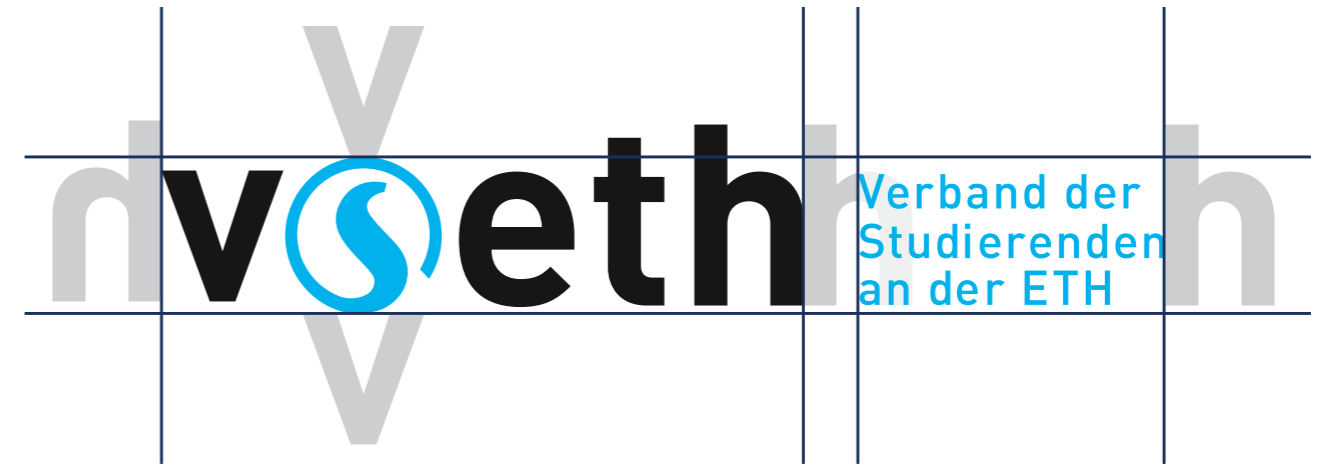

The Signet

The signet of the VSETH should only be used as a stand-alone with the intention of an icon or design element. Examples are social icons, e.g. Facebook avatar, favicon on the VSETH websites, or as a design element on merchandise. The signet has a defined clear space of a third of the icon's width when used as a social icon.

It should **not** be used as a logo replacement.

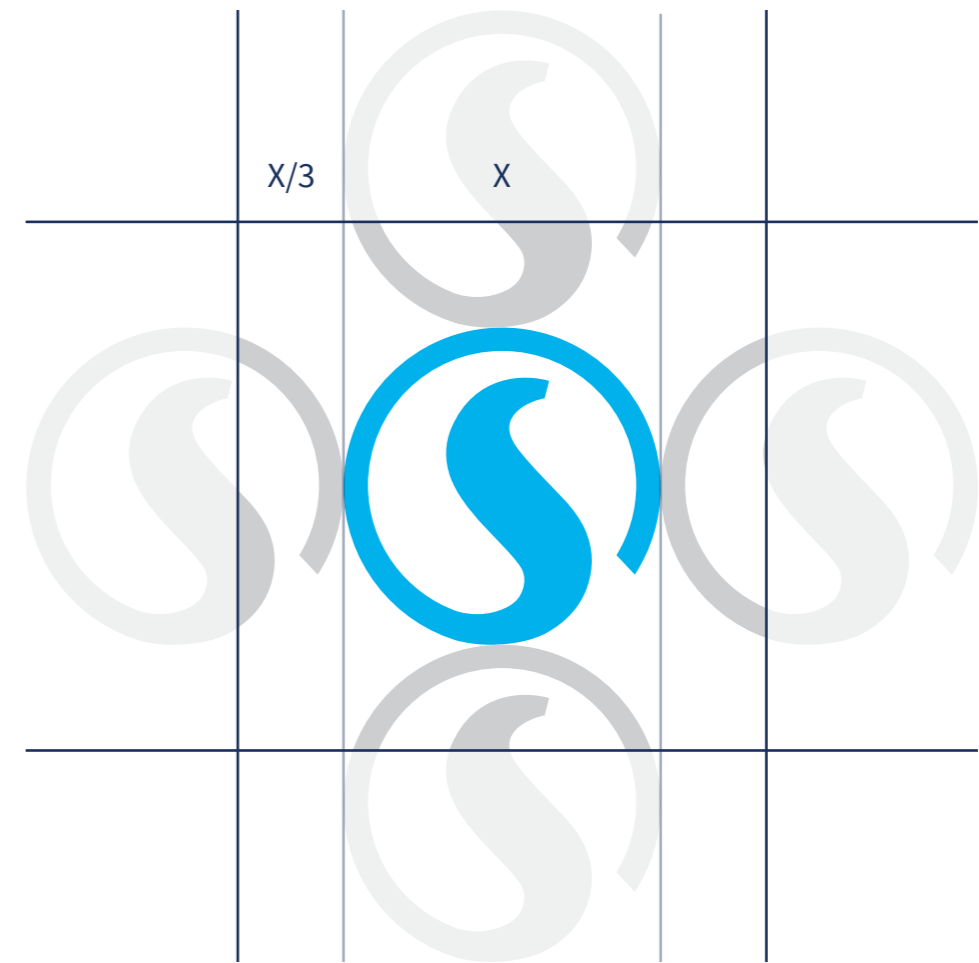

The Byline

There are 4 different versions of the VSETH logo. One for the VSETH itself, then one for each; the study associations (Fachvereine), the committees (Kommissionen), and the student organizations (Organisationen). Other VSETH bodies (e.g. Ausschüsse, AGs, etc.) use the logo version without a specific byline. The byline is always in German, and its use is mandatory unless stated otherwise.

Exceptions where **no byline** is needed:

- The VSETH logo is too small and the byline is unreadable
- The VSETH logo as the header logo in websites
- Posters that are on screen only (for printed posters it is mandatory)

veth **Verband der Studierenden an der ETH**

veth **Fachverein**
Verband der Studierenden an der ETH

veth **Kommission**
Verband der Studierenden an der ETH

veth **Organisation**
Verband der Studierenden an der ETH

Color

The VSETH logo has four color variations:

- The **default** should be used for uniform lighter backgrounds where the cyan is clearly distinct from the background (at least 20% color difference*)
- The **inverse** should be used for uniform darker backgrounds and the cyan is clearly distinct from the background (at least 20% color difference*)
- The **black** should be used for lighter non-uniform backgrounds
- The **white** should be used for darker non-uniform backgrounds

* Color difference to cyan is defined in the RGB color space as following:

```
color_difference = (
  red(background)
  + (max{ green(background), 159 } - min{ green(background), 159 })
  + (max{ blue(background), 227 } - min{ blue(background), 227 })
) / 765
color_difference_percent = color_difference * 100%
```



Scale

Our logo has two versions, one version with a byline and another without a byline. The byline version can only be used in larger sizes, to keep the readability of the byline. The logo with byline should be at least 4.5 centimeters wide. This corresponds to 126 pixels at 72 dpi, 170 pixels at 96 dpi, and 531 pixels at 300 dpi.

The logo version without a byline is used in smaller sizes and is scalable down to the smallest size of 2.0 centimeters wide. This corresponds to 56 pixels at 72 dpi, 76 pixels at 96 dpi, and 236 pixels at 300 dpi.

veth **Verband der Studierenden an der ETH**

veth **Verband der Studierenden an der ETH**

veth **Verband der Studierenden an der ETH**

veth **Verband der Studierenden an der ETH**

veth

veth

Logo Don'ts

Our logo is provided as defined on the previous pages. It should **not** be altered in any other way. This includes:

- Recoloring the logo, this includes shades of gray
- Stretching or Condensing
- Altering or rearranging the logo, this includes the byline. There are always humorous interpretations of the byline - but we ask you not to use them for official presence.
- Rotating or Flipping; exception are rotation of 90°, respectively 270°.
- Using with different typefaces

The VSETH logo should also not be used as part of a sentence or headline. The correct way is to use plain text in uppercase or its full name “Verband der Studierenden an der ETH”.

~~vseth~~

~~vseth~~

~~vseth~~

~~vseth~~

Guidance

We have a defined minimum logo size for paper format DIN A6 to A0 for portrait and landscape format. Note that for A5 and A6 you should not use a byline on the logo. The size of the logo in the chart is given by the width of the logo without clear space. But the clear space of the logo should always be respected.

On websites headers and screen advertisement the logo without byline should be used. On other parts of the website the logo with byline should be used and, thus, the minimum size of the logo must be respected.

When the VSETH logo is used in combination with logos of sub-organizations, the logos should be of similar size.

Format	Byline	Width
A6	No	20 mm
A5	No	25 mm
A4	Yes	57 mm
A3	Yes	75 mm
A2	Yes	100 mm
A1	Yes	130 mm
A0	Yes	170 mm
Screen	No	50 mm

Creative Freedom

Our goal is not to completely restrict the usage of the logo. That is, the logo can still be used in illustrations for posters, brochures or booklets in a modified state. This can be, for example, the logo with a graffiti effect, stretched and skewed to fit into a 3D space, color adapted to fit in more naturally, etc. But all those formats should always include an unmodified version of the logo.

Important to note here is that the core values of the logo must not be lost. For example, if you choose to recolor the logo it should only be to fit the logo into its surrounding. So changing the color values to complete different color is not allowed. The same rule applies to the form. You cannot change the logo to an unrecognizable state.



Color

Colors draw attention and create associations in our mind. The VSETH is represented by its main color Cyan which gives an elegance and professionalism to the brand. Our accent color, Salsa Red, on the other hand, fuses the energy to the brand and spices up the overall professionally-held design.



Color Definition

Our primary brand colors are **Cyan** and **Salsa Red**. Whereby Cyan is the most dominant color in the overall design, since Salsa Red is only used to set certain accents and spice it up.

Our secondary colors are **Space Cadet** and **Giant's Club**. They should only be used sparingly throughout illustration, photography, and product in order to maintain meaning.

For clothes and other fabrics the color PANTONE 16-4529 TCX (Cyan Blue) should be used.

The color palette consists of four color swatches arranged in a grid. The first swatch is Cyan, the second is Giant's Club, the third is Space Cadet, and the fourth is Salsa Red. Each swatch contains its name and technical color data.

Color Name	CMYK	RGB	HEX	PMS
Cyan	100, 0, 0, 0	0, 159, 227	#009FE3	P Cyan C
Giant's Club	0, 74, 43, 26	175, 91, 91	#AF5B5B	P 61-5 C
Space Cadet	100, 71, 0, 51	24, 48, 89	#183059	534 C
Salsa Red	0, 89, 66, 0	240, 58, 71	#F03A47	1787 C

Usage Proportions

It is important to follow the rules of these proportions when creating any brand communication in order to maintain brand consistency. White plays a very important role in all brand communications and should provide balance with black. Cyan is employed to highlight things and should be used sparingly. Salsa Red is only to spice things up, thus, should only be used in illustrations and within products.

Notable applications for cyan are the iconic bar at the bottom of documents or the colored letters to indicate date, author, etc.

Proportion on Text Documents



Proportion on Websites



Composition

Our composition system is simple and practical. One of our main design elements is the cyan line, which helps separate content or mark the end of a page.



The Line

The cyan line has a stroke width of 1 mm on DIN A4 and should be scaled with the content. The cyan line should be as wide as the content of the page. When the line is used on top of pictures or non-uniform illustrations, either the white or black variation of the line should be used.

For posters, a thicker variation of the line can be used.

The cyan line can be used to separate content, to mark the end of the page in the form of a bottom line, or to highlight a title in presentations.

On documents, the bottom line can have content next to the line such as page number, or repeated content such as the address. This content should have a distance of 2 mm from the line.



LOREM IPSUM DOLOR

- Lorem ipsum dolor sit
- Amet consectetur adipiscing elit
- Diam nonummy nibh
- Euismod tincidunt ut laoreet
- Magna aliquam erat
- Volutpat ut wisi enim
- Minim veniam quis

voeth Technische Hogeschool van Eindhoven

LOREM IPSUM
lit eget gravida cum sociis natoque

LOREM IPSUM DOLOR SIT AMET, CONSECTETUR ADIPISCING ELIT, SED DO EIUSMOD TEMPOR INCIDidunt ut elidunt. Ut enim ad minima veniam, quis nostrum exercitationem ullam corporis suscipit laboriosam, nisi ut aliquid ex ea commodi consequatur? Quis autem vel eum iure reprehenderit qui se ipsum deiecit in voluptate, in voluptate in voluptate? Ut enim ad minima veniam, quis nostrum exercitationem ullam corporis suscipit laboriosam, nisi ut aliquid ex ea commodi consequatur? Quis autem vel eum iure reprehenderit qui se ipsum deiecit in voluptate, in voluptate in voluptate?

LOREM IPSUM
lit eget gravida cum sociis natoque

LOREM IPSUM DOLOR SIT AMET, CONSECTETUR ADIPISCING ELIT, SED DO EIUSMOD TEMPOR INCIDidunt ut elidunt. Ut enim ad minima veniam, quis nostrum exercitationem ullam corporis suscipit laboriosam, nisi ut aliquid ex ea commodi consequatur? Quis autem vel eum iure reprehenderit qui se ipsum deiecit in voluptate, in voluptate in voluptate? Ut enim ad minima veniam, quis nostrum exercitationem ullam corporis suscipit laboriosam, nisi ut aliquid ex ea commodi consequatur? Quis autem vel eum iure reprehenderit qui se ipsum deiecit in voluptate, in voluptate in voluptate?

LOREM IPSUM
lit eget gravida cum sociis natoque

LOREM IPSUM DOLOR SIT AMET, CONSECTETUR ADIPISCING ELIT, SED DO EIUSMOD TEMPOR INCIDidunt ut elidunt. Ut enim ad minima veniam, quis nostrum exercitationem ullam corporis suscipit laboriosam, nisi ut aliquid ex ea commodi consequatur? Quis autem vel eum iure reprehenderit qui se ipsum deiecit in voluptate, in voluptate in voluptate? Ut enim ad minima veniam, quis nostrum exercitationem ullam corporis suscipit laboriosam, nisi ut aliquid ex ea commodi consequatur? Quis autem vel eum iure reprehenderit qui se ipsum deiecit in voluptate, in voluptate in voluptate?

LOREM IPSUM

LOREM IPSUM DOLOR SIT AMET, CONSECTETUR ADIPISCING ELIT, SED DO EIUSMOD TEMPOR INCIDidunt ut elidunt. Ut enim ad minima veniam, quis nostrum exercitationem ullam corporis suscipit laboriosam, nisi ut aliquid ex ea commodi consequatur? Quis autem vel eum iure reprehenderit qui se ipsum deiecit in voluptate, in voluptate in voluptate? Ut enim ad minima veniam, quis nostrum exercitationem ullam corporis suscipit laboriosam, nisi ut aliquid ex ea commodi consequatur? Quis autem vel eum iure reprehenderit qui se ipsum deiecit in voluptate, in voluptate in voluptate?



6. Februar 2020 VERBODEN DEELTAKEN/DEELNAME AN DER ETV 1

voeth Technische Hogeschool van Eindhoven

LOREM IPSUM
lit eget gravida cum sociis natoque

LOREM IPSUM DOLOR SIT AMET, CONSECTETUR ADIPISCING ELIT, SED DO EIUSMOD TEMPOR INCIDidunt ut elidunt. Ut enim ad minima veniam, quis nostrum exercitationem ullam corporis suscipit laboriosam, nisi ut aliquid ex ea commodi consequatur? Quis autem vel eum iure reprehenderit qui se ipsum deiecit in voluptate, in voluptate in voluptate? Ut enim ad minima veniam, quis nostrum exercitationem ullam corporis suscipit laboriosam, nisi ut aliquid ex ea commodi consequatur? Quis autem vel eum iure reprehenderit qui se ipsum deiecit in voluptate, in voluptate in voluptate?

LOREM IPSUM
lit eget gravida cum sociis natoque

LOREM IPSUM DOLOR SIT AMET, CONSECTETUR ADIPISCING ELIT, SED DO EIUSMOD TEMPOR INCIDidunt ut elidunt. Ut enim ad minima veniam, quis nostrum exercitationem ullam corporis suscipit laboriosam, nisi ut aliquid ex ea commodi consequatur? Quis autem vel eum iure reprehenderit qui se ipsum deiecit in voluptate, in voluptate in voluptate? Ut enim ad minima veniam, quis nostrum exercitationem ullam corporis suscipit laboriosam, nisi ut aliquid ex ea commodi consequatur? Quis autem vel eum iure reprehenderit qui se ipsum deiecit in voluptate, in voluptate in voluptate?

LOREM IPSUM
lit eget gravida cum sociis natoque

LOREM IPSUM DOLOR SIT AMET, CONSECTETUR ADIPISCING ELIT, SED DO EIUSMOD TEMPOR INCIDidunt ut elidunt. Ut enim ad minima veniam, quis nostrum exercitationem ullam corporis suscipit laboriosam, nisi ut aliquid ex ea commodi consequatur? Quis autem vel eum iure reprehenderit qui se ipsum deiecit in voluptate, in voluptate in voluptate? Ut enim ad minima veniam, quis nostrum exercitationem ullam corporis suscipit laboriosam, nisi ut aliquid ex ea commodi consequatur? Quis autem vel eum iure reprehenderit qui se ipsum deiecit in voluptate, in voluptate in voluptate?



6. Februar 2020 VERBODEN DEELTAKEN/DEELNAME AN DER ETV 1

Separation of Content

Sometimes, it is necessary to mark a clear separation between different contents in a document or presentation, and a thin line is not enough. There, a fat bar with 75% of the height of the page is used. The section title and description can be written on the bar.

This cyan bar should be used for presentations in landscape mode or spread over two pages in a booklet. Alternatively, it can also be an image with low frequency, a video (in presentations), or part of the bar can be an image.

For printed assets: the cyan bar requires a bleed and the ability to trim. If you are using a standard office printer and are unable to trim the final print, do not use the cyan bar.

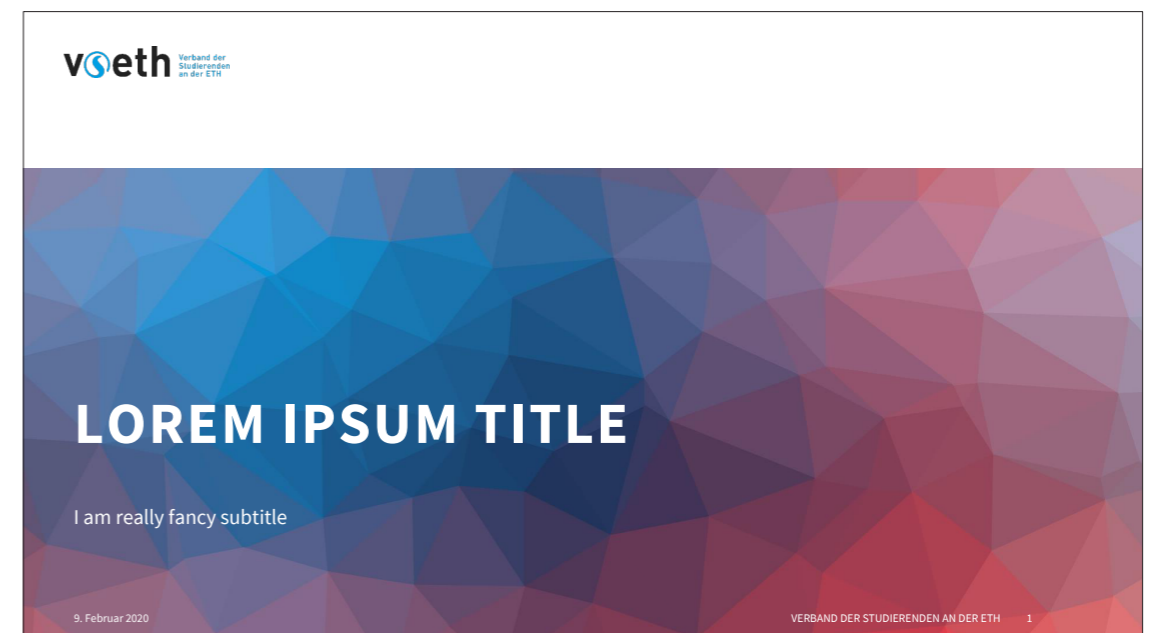
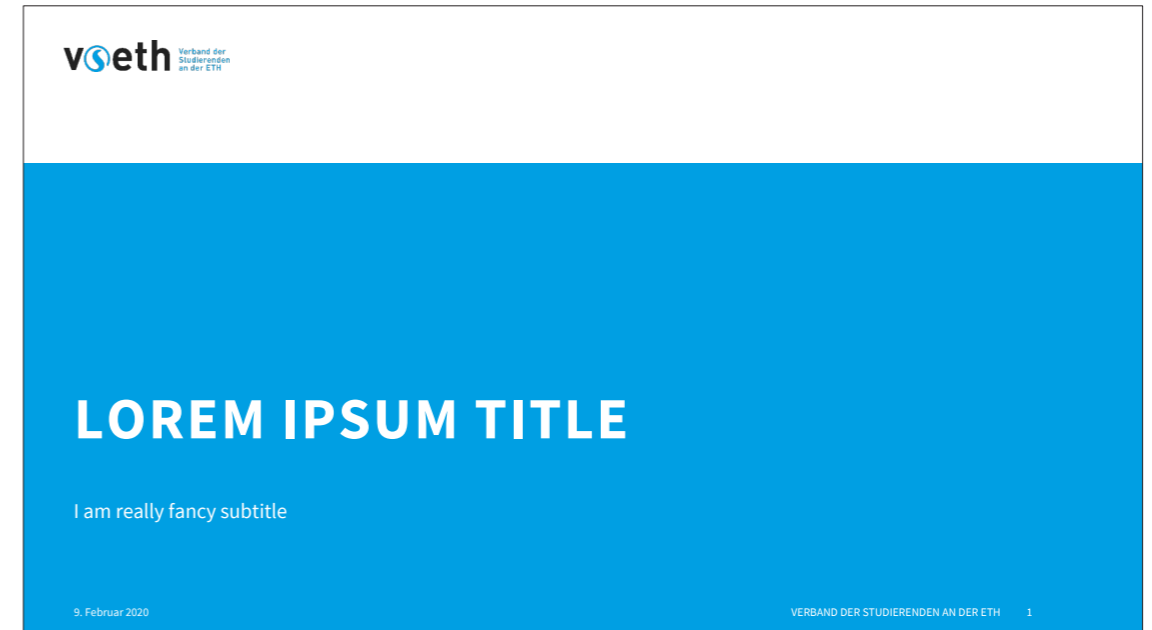

Base Layout Documents

To define the content width, the key factor is the readability of the text. The optimal line length for the body text is considered to be 50-75 characters per line, including spaces. We decided to go with the upper bound of this rule, hence, with a text size of 11 pt, we get roughly a **content width** of 15 cm. This results in a **left and right margin** of 3 cm on DIN A4.

The top and bottom margin are defined differently. The **top margin** is defined separately on the first page and the following pages. On the first page it has a defined margin of 2 cm and on the following page it is 2 cm plus an additional 1 cm space after the logo. The **bottom margin** is 2 cm from the line to the end of the page and another 1 cm from the line to the content.

The white space in the top and bottom margins can be used to place repeated content such as page number, section titles, or the address of the VSETH.

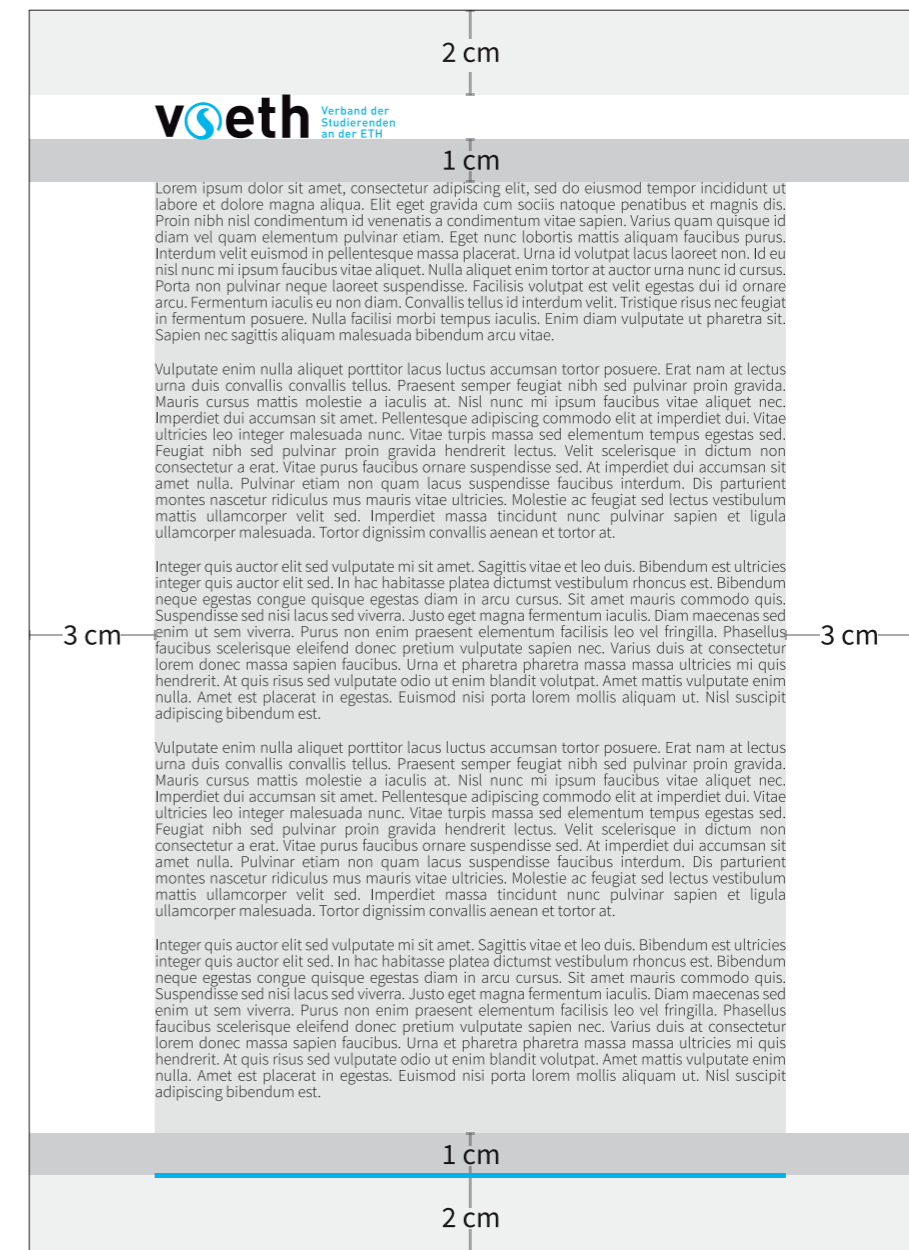
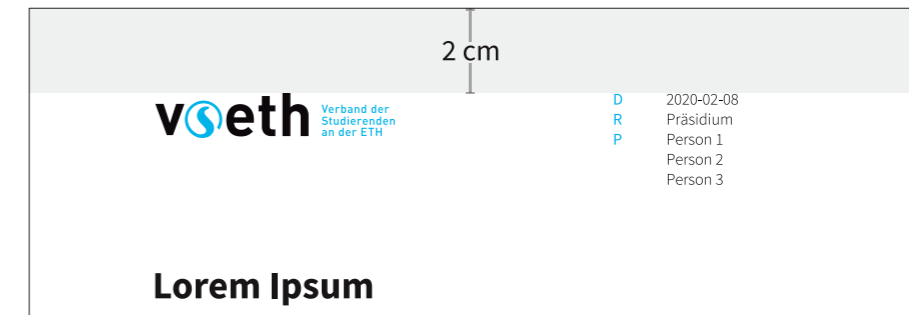

The First Page

Documents

The first page of a VSETH document should always have the **logo** on the top left of the page. In addition to the logo, on the top right is the **document information**, such as telephone number, email, author(s), date, etc. The type of information is marked with the first letter of the type. The only exception, the “Your contact person” or “Ihre Ansprechperson” should always be written in full length to prevent misunderstandings. There is an 1 cm spacing between the information type and the document information itself.

The **document title** follows after a 2 cm spacing from the lowest point of the above mentioned content.

The diagram illustrates the layout of a document page. At the top left is the **vsoeth** logo (Verband der Studierenden an der ETH). At the top right is the document information: 'D 2020-02-08', 'R Präsidium', 'P Person 1', 'Person 2', and 'Person 3'. A 1 cm spacing is indicated between the logo and the document information. Below this is a grey horizontal bar. Below the bar, the title 'Lorem Ipsum' is followed by a 2 cm spacing. The body text consists of three paragraphs of Lorem Ipsum, followed by a page number '- XX/XX -' and a footer line: 'VSETH - CAB E 27 - Universitätstrasse 6 - 8092 Zürich - +41 44 632 42 98 - vseth@vseth.ethz.ch'.

Bound Document Documents

Documents that are to bound together should have an additional **gutter** of 1 cm on the inner margins. In addition to the gutter, the page number should not be placed in the center of the page but should be placed at the outer end of the page. For bound documents the logo placement should also alternate. The logo should be placed at the outer end of the page.

The gutter should not be applied to the cover page of the document.

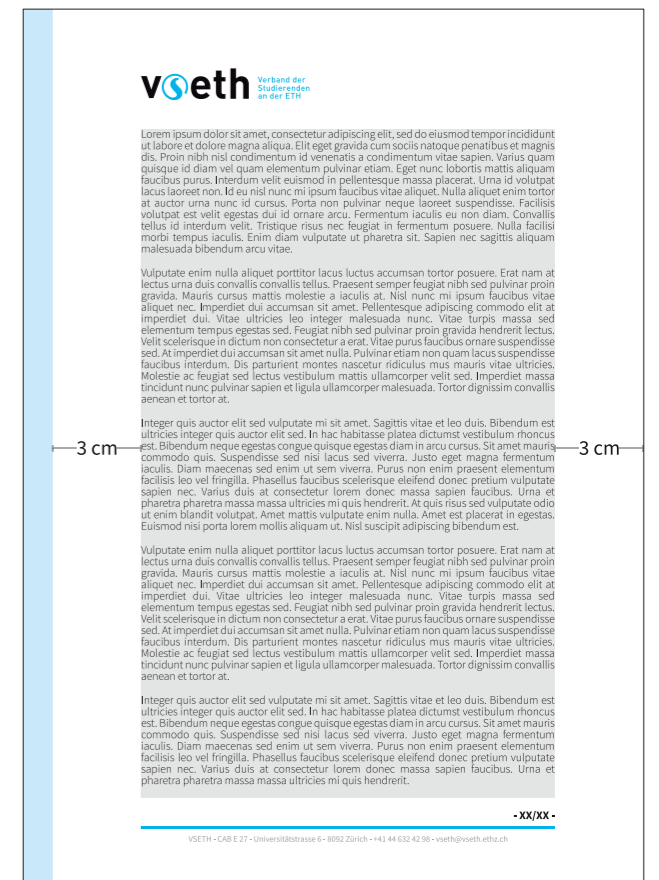
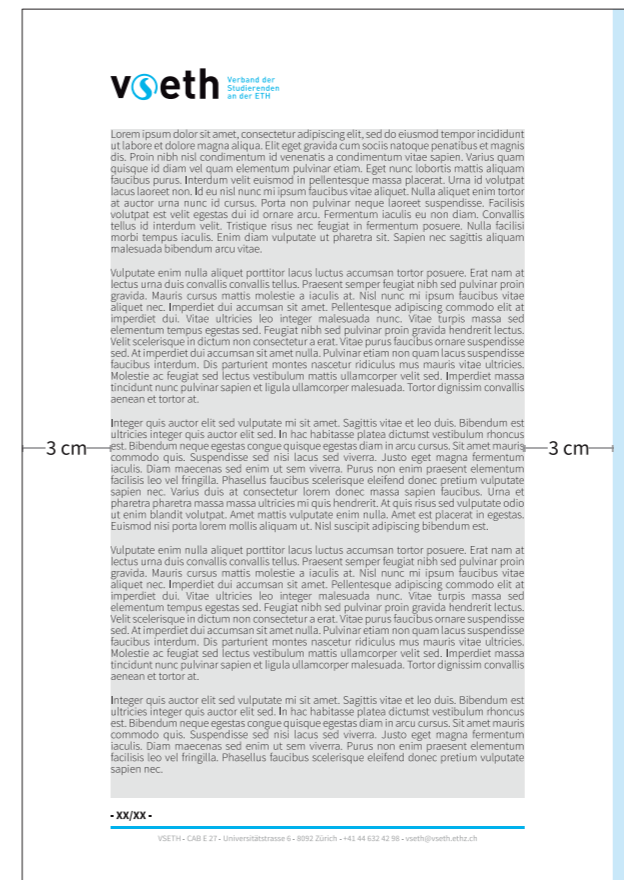

Protocols

Documents

The top section of the protocol is similar with the standard document but without the document information on the top right corner. The document information in a protocol is just below the title. Between each line of the document information is a 4 mm space. Before and after the document information is 1 cm space each.

2 cm

vsoeth Verband der Studierenden an der ETH

2.3 cm

2 cm

Protokoll - Lorem Ipsum Sitzung

1 cm 1 cm

Sitzung	DD.MM.YYYY, Uhrzeit, Ort
Anwesend	Person 1 (Abkürzung 1), Person 2 (Abkürzung 2), ...
Gäste	Person 1 (Abkürzung 1), Person 2 (Abkürzung 2), ...
Sitzungsleitung	Abkürzung Sitzungsleitung

4 mm

1 cm

1. Traktandum 1

Dis parturient montes nascetur ridiculus mus mauris vitae ultricies. Molestie ac feugiat sed lectus vestibulum mattis ullamcorper velit sed. Imperdiet massa tincidunt nunc pulvinar sapien et ligula ullamcorper malesuada. Tortor dignissim convallis aenean et tortor at.

2. Traktandum 2

Lorem ipsum dolor sit amet, consectetur adipiscing elit, sed do eiusmod tempor incididunt ut labore et dolore magna aliqua. Elit eget gravida cum sociis natoque penatibus et magnis dis. Proin nibh nisl condimentum id venenatis a condimentum vitae sapien. Varius quam quisque id diam vel quam elementum pulvinar etiam. Eget nunc lobortis mattis aliquam faucibus purus. Interdum velit euismod in pellentesque massa placerat. Urna id volutpat lacus laoreet non. Id eu nisl nunc mi ipsum faucibus vitae aliquet. Nulla aliquet enim tortor at auctor urna nunc id cursus. Porta non pulvinar neque laoreet suspendisse. Facilisis volutpat est velit egestas dui id ornare arcu. Fermentum iaculis eu non diam. Convallis tellus id interdum velit. Tristique risus nec feugiat in fermentum posuere. Nulla facilisi morbi tempus iaculis. Enim diam vulputate ut pharetra sit. Sapien nec sagittis aliquam malesuada bibendum arcu vitae.

a. Untertraktandum 1

Vulputate enim nulla aliquet porttitor lacus luctus accumsan tortor posuere. Erat nam at lectus urna duis convallis convallis tellus. Praesent semper feugiat nibh sed pulvinar proin gravida. Mauris cursus mattis molestie a iaculis at. Nisl nunc mi ipsum faucibus vitae aliquet nec. Imperdiet dui accumsan sit amet. Pellentesque adipiscing commodo elit at imperdiet dui. Vitae ultricies leo integer malesuada nunc. Vitae turpis massa sed elementum tempus egestas sed. Feugiat nibh sed pulvinar proin gravida hendrerit lectus. Velit scelerisque in dictum non consectetur a erat. Vitae purus faucibus ornare suspendisse sed.

3. Varia

Vulputate enim nulla aliquet porttitor lacus luctus accumsan tortor posuere. Erat nam at lectus urna duis convallis convallis tellus. Praesent semper feugiat nibh sed pulvinar proin gravida. Mauris cursus mattis molestie a iaculis at. Nisl nunc mi ipsum faucibus vitae aliquet nec. Imperdiet dui accumsan sit amet. Pellentesque adipiscing commodo elit at imperdiet dui.

- XX/XX -

VSETH - CAB E 27 - Universitätstrasse 6 - 8092 Zürich - +41 44 632 42 98 - vseth@vseth.ethz.ch

Letters, Contracts

Documents

The spacing in letters, contracts, and proposals is dependent on the placement of the receiving address. In order for the letter work with window envelopes, the address has to be in a box roughly the size of 4 by 8.5 cm and placed 2 cm from the left border of the paper and 5 cm from the top. To guarantee the readability of the letter's address even when the paper is moving around a bit in the envelope, we also leave a 2 mm margin inside the box.

The space to the right of the address box can be used for document information.

The content of the letter starts after a 1 cm spacing from the box.

The diagram illustrates the layout of a letter on a page. The address box is positioned 5 cm from the top and 2 cm from the left edge. The address box itself is 4 cm high and 8.5 cm wide. The address text is left-aligned within the box. To the right of the address box, there is a 2 cm wide area for document information. The letter content starts 1 cm from the left edge of the page. The footer contains the text '- XX/XX -' and the contact information for VSETH.

5 cm **vseth** Verband der Studierenden an der ETH

1 cm **2 cm**

2 cm **4 mm** **4 mm**

8 mm **1 cm**

Betreff

Sehr geehrte Frau Mustfrau,

Lorem ipsum dolor sit amet, consectetur adipiscing elit, sed do eiusmod tempor incididunt ut labore et dolore magna aliqua. Elit eget gravida cum sociis natoque penatibus et magnis dis. Proin nibh nisl condimentum id venenatis a condimentum vitae sapien. Varius quam quisque id diam vel quam elementum pulvinar etiam. Eget nunc lobortis mattis aliquam faucibus purus. Interdum velit euismod in pellentesque massa placerat. Urna id volutpat lacus laoreet non. Id eu nisl nunc mi ipsum faucibus vitae aliquet. Nulla aliquet enim tortor at auctor urna nunc id cursus. Porta non pulvinar neque laoreet suspendisse. Facilisis volutpat est velit egestas dui id ornare arcu. Fermentum iaculis eu non diam. Convallis tellus id interdum velit. Tristique risus nec feugiat in fermentum posuere. Nulla facilisi morbi tempus iaculis. Enim diam vulputate ut pharetra sit. Sapien nec sagittis aliquam malesuada bibendum arcu vitae.

Vulputate enim nulla aliquet porttitor lacus luctus accumsan tortor posuere. Erat nam at lectus urna duis convallis convallis tellus. Praesent semper feugiat nibh sed pulvinar proin gravida. Mauris cursus mattis molestie a iaculis at. Nisl nunc mi ipsum faucibus vitae aliquet nec. Imperdiet dui accumsan sit amet. Pellentesque adipiscing commodo elit at imperdiet dui. Vitae ultricies leo integer malesuada nunc. Vitae turpis massa sed elementum tempus egestas sed. Feugiat nibh sed pulvinar proin gravida hendrerit lectus. Velit scelerisque in dictum non consectetur a erat. Vitae purus faucibus ornare suspendisse sed. At imperdiet dui accumsan sit amet nulla. Pulvinar etiam non quam lacus suspendisse faucibus interdum. Dis parturient montes nascetur ridiculus mus mauris vitae ultricies. Molestie ac feugiat sed lectus vestibulum mattis ullamcorper velit sed. Imperdiet massa tincidunt nunc pulvinar sapien et ligula ullamcorper malesuada. Tortor dignissim convallis aenean et tortor at.

Integer quis auctor elit sed vulputate mi sit amet. Sagittis vitae et leo duis. Bibendum est ultricies integer quis auctor elit sed. In hac habitasse platea dictumst vestibulum rhoncus est. Bibendum neque egestas congue quisque egestas diam in arcu cursus. Sit amet mauris commodo quis. Suspendisse sed nisi lacus sed viverra. Justo eget magna fermentum iaculis. Diam maecenas sed enim ut sem viverra. Purus non enim praesent elementum facilisis leo vel fringilla. Phasellus faucibus scelerisque eleifend donec pretium vulputate sapien nec. Varius duis at consectetur lorem donec massa sapien faucibus. Urna et pharetra pharetra massa massa ultricies mi quis hendrerit. At quis risus sed vulputate odio ut enim blandit volutpat. Amet mattis vulputate enim nulla. Amet est placerat in egestas. Euismod nisi porta lorem mollis aliquam ut. Nisl suscipit adipiscing bibendum est.

- XX/XX -

VSETH - CAB E 27 - Universitätstrasse 6 - 8092 Zürich - +41 44 632 42 98 - vseth@vseth.ethz.ch

Suborganizations Documents

VSETH Documents created by suborganizations should include the VSETH logo with the correct byline in top left corner. Further, for document types which don't have the document information in the top right corner, the logo of the suborganization should be placed there. The logo should, if possible, be of similar size as the VSETH logo and should not exceed a width of 8 cm and a height of 2.3 cm. The space between the logos should not be smaller than 1.3 cm.

For the rest of the document, the same rules as the other VSETH documents are applied.

Protokoll - GECo Sitzung

Sitzung	DD.MM.YYYY, Uhrzeit, Ort
Anwesend	Person 1 (Abkürzung 1), Person 2 (Abkürzung 2), ...
Gäste	Person 1 (Abkürzung 1), Person 2 (Abkürzung 2), ...
Sitzungsleitung	Abkürzung Sitzungsleitung

1. Traktandum 1

Dis parturient montes nascetur ridiculus mus mauris vitae ultricies. Molestie ac feugiat sed lectus vestibulum mattis ullamcorper velit sed. Imperdiet massa tincidunt nunc pulvinar sapien et ligula ullamcorper malesuada. Tortor dignissim convallis aenean et tortor at.

2. Traktandum 2

Lorem ipsum dolor sit amet, consectetur adipiscing elit, sed do eiusmod tempor incididunt ut labore et dolore magna aliqua. Elit eget gravida cum sociis natoque penatibus et magnis dis. Proin nibh nisl condimentum id venenatis a condimentum vitae sapien. Varius quam quisque id diam vel quam elementum pulvinar etiam. Eget nunc lobortis mattis aliquam faucibus purus. Interdum velit euismod in pellentesque massa placerat. Urna id volutpat lacus laoreet non. Id eu nisl nunc mi ipsum faucibus vitae aliquet. Nulla aliquet enim tortor at auctor urna nunc id cursus. Porta non pulvinar neque laoreet suspendisse. Facilisis volutpat est velit egestas dui id ornare arcu. Fermentum iaculis eu non diam. Convallis tellus id interdum velit. Tristique risus nec feugiat in fermentum posuere. Nulla facilisi morbi tempus iaculis. Enim diam vulputate ut pharetra sit. Sapien nec sagittis aliquam malesuada bibendum arcu vitae.

a. Untertraktandum 1

Vulputate enim nulla aliquet porttitor lacus luctus accumsan tortor posuere. Erat nam at lectus urna duis convallis convallis tellus. Praesent semper feugiat nibh sed pulvinar proin gravida. Mauris cursus mattis molestie a iaculis at. Nisl nunc mi ipsum faucibus vitae aliquet nec. Imperdiet dui accumsan sit amet. Pellentesque adipiscing commodo elit at imperdiet dui. Vitae ultricies leo integer malesuada nunc. Vitae turpis massa sed elementum tempus egestas sed. Feugiat nibh sed pulvinar proin gravida hendrerit lectus. Velit scelerisque in dictum non consectetur a erat. Vitae purus faucibus ornare suspendisse sed.

3. Varia

Vulputate enim nulla aliquet porttitor lacus luctus accumsan tortor posuere. Erat nam at lectus urna duis convallis convallis tellus. Praesent semper feugiat nibh sed pulvinar proin gravida. Mauris cursus mattis molestie a iaculis at. Nisl nunc mi ipsum faucibus vitae aliquet nec. Imperdiet dui accumsan sit amet. Pellentesque adipiscing commodo elit at imperdiet dui.

- XX/XX -

VSETH - CAB E 27 - Universitätstrasse 6 - 8092 Zürich - +41 44 632 42 98 - vseth@vseth.ethz.ch

Base Layout Website

Websites and web applications of the VSETH have a very simple but consistent visual language. They are mostly white and black with some highlights made in the primary color of the website (for websites and web application provided directly by the VSETH this is cyan). One of the most eye-catching elements is the dual header. The top header is colored in the primary color of the website's design and the second header is in plain white. The VSETH logo is always placed in the top header and the website's logo or title in the second header.

Another important aspect is the switch to bottom navigation on smaller devices.

A more detailed discussion on this topic can be found in the front-end component documentation (frontend.getsip.ethz.ch).

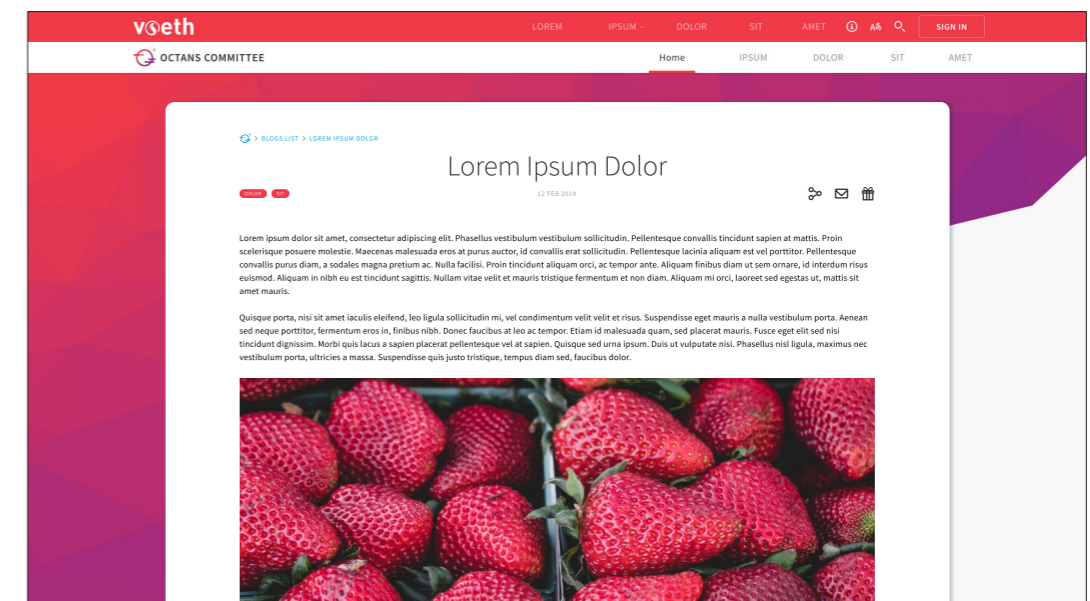
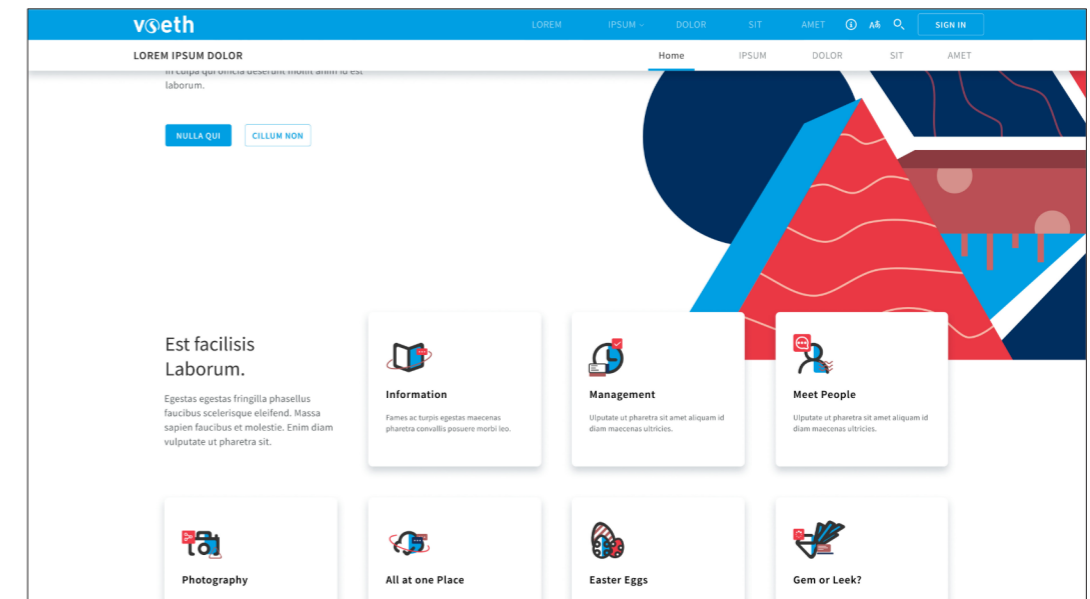

Typography

Our typography is easy to use and freely accessible. It was chosen among countless other fonts for its readability and almost a complete character set.

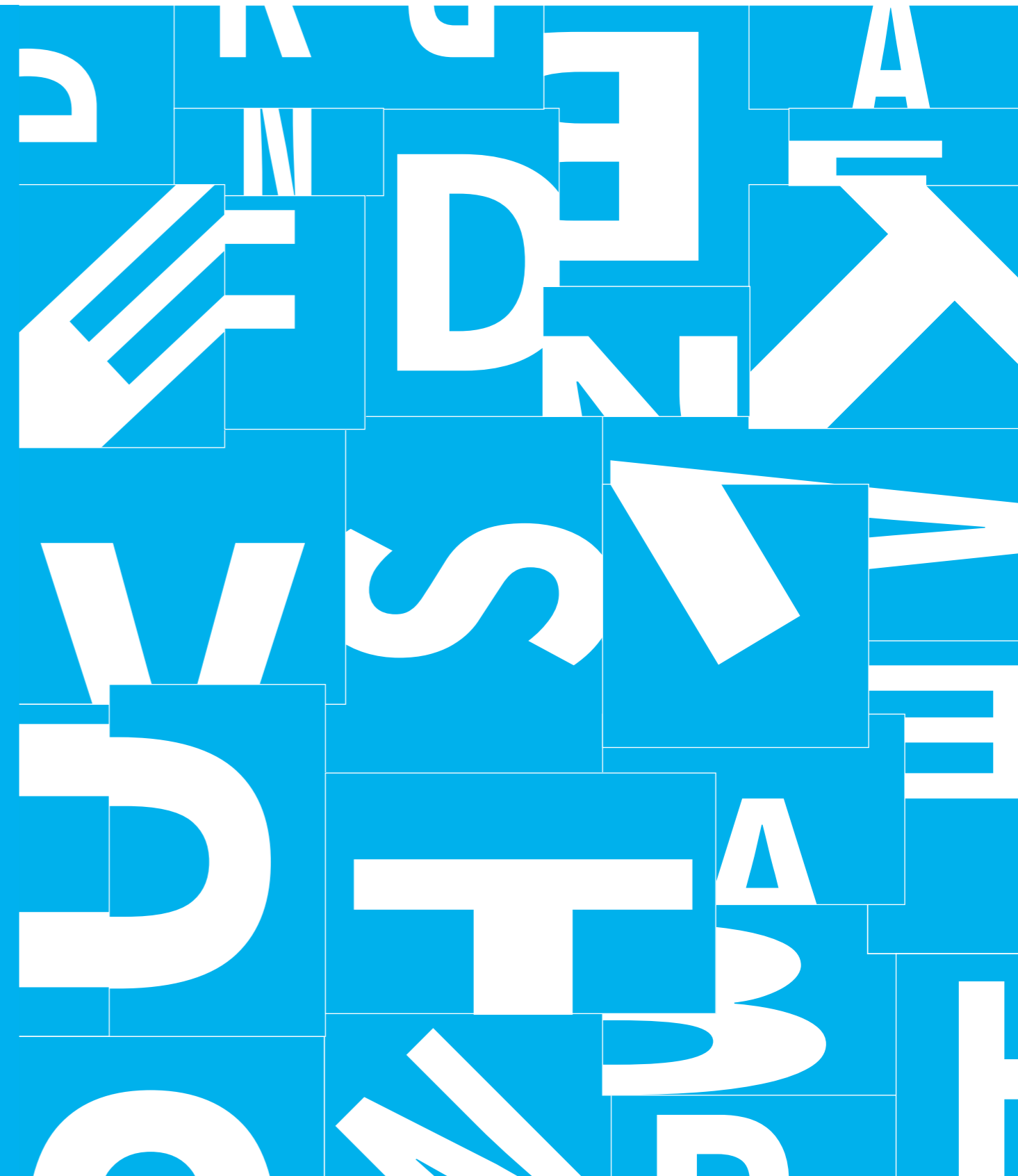

Source Sans Pro

Source Sans Pro is the first open source typeface family from Adobe and is a sans-serif typeface intended to work well in user interfaces and on paper. It comes with a lightweight typeface that is easy on the eye. Source Sans Pro has been selected for its versatility and legibility from a large number of other fonts. It offers many weights and styles which provides versatility and flexibility for graphic communication.

The integrity of the font should be maintained at all times. No vertical or horizontal scaling, no added stroke, etc.

Source Sans Pro supports different font weights, but here it is important to bear in mind that Light should normally be used on print medias and Regular on Screen medias. The Light font-weights are beautiful in design but can get demanding for the eyes to read on screen over a longer period of time.

Aa

Source Sans Pro

The quick brown fox
jumps over the lazy dog.
?!()*&/,.;:”<>+ -=
1234567890

Light

Regular

Semi-Bold

Bold

Black

Hierarchy

Documents

The base font size of documents is 11 pt in Light Source Sans Pro. The text should be left aligned or left justified (Blocksatz). To set a contrast to the black and white document, we use cyan colored headings for sub-sections (heading 2).

Note that in letters, contracts, and proposals, the subject (Betreff) is a heading 1 category and not a title.

This hierarchy is for official documents. “Stylized” documents, such as brochures, booklets, etc., do not have to follow this hierarchy.

Category	Weight	Size	Color
Title	Bold	26 pt	Black (CMYK: 0, 0, 0, 100)
Subtitle	Regular	15 pt	Gray (CMYK: 0, 0, 0, 60)
Heading 1	Bold	20 pt	Black (CMYK: 0, 0, 0, 100)
Heading 2	Bold	16 pt	Cyan (CMYK: 100, 0, 0, 0)
Heading 3	Bold	14 pt	Black (CMYK: 0, 0, 0, 100)
Paragraph	Light	11 pt	Black (CMYK: 0, 0, 0, 100)

Hierarchy

Website

The most important rule for type hierarchy on websites is not to use cyan colored headings. This may work on paper, but on websites it is misleading and can be easily confused with a link.

The title of the website can also be customized, that is, different font weight, different font size etc. The rest of the definitions should be used as is and not be altered.

Category	Weight	Size	Letterspacing
Title	Light	4.5 rem	-1.5%
Subtitle	Regular	1.125 rem	2%
Heading 1	Light	3.25 rem	-0.5%
Heading 2	Semi-Bold	2.5 rem	0%
Heading 3	Regular	2.25 rem	0%
Heading 4	Semi-Bold	1.875 rem	0%
Heading 5	Bold	1.5 rem	2%
Heading 6	Semi-Bold	1.25 rem	4%
Body 1	Regular	1 rem	2%
Body 2	Regular	0.875 rem	2%
Caption	Regular	0.75 rem	8%
OVERLINE	Regular	0.75 rem	8%

Guidance

We have a few rules that should be followed when writing for the VSETH:

- Do not use colored typography; except for headings on documents or to mark something important
- Do not use all caps; we don't want to shout at people, so avoid using all caps if not for an abbreviation
- Do not adjust kerning or tracking; changing the letterspacing worsens the legibility
- Do not separate chunks of text

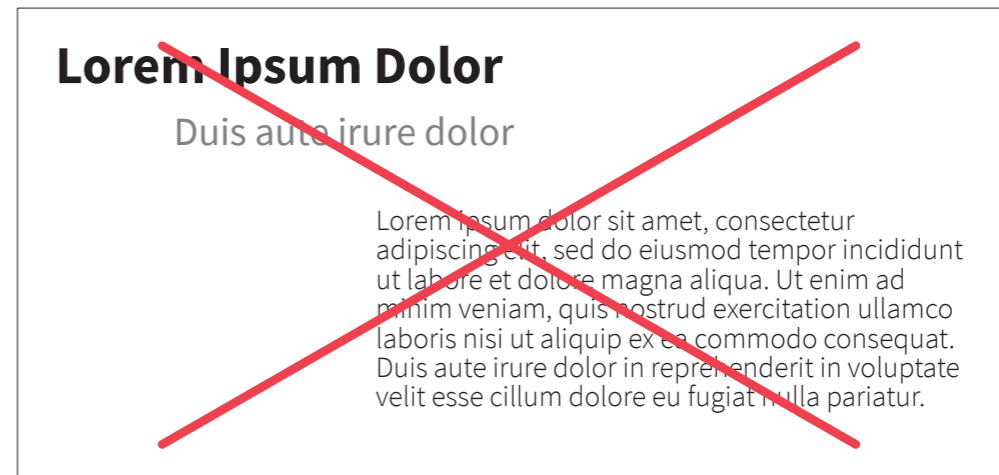
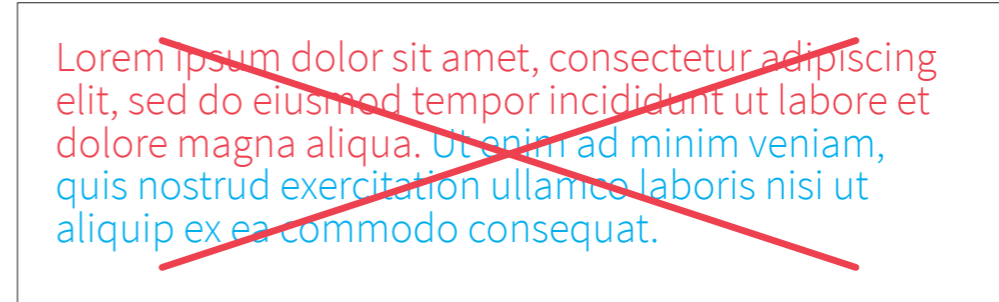

Iconography

Our iconography is connected to our typography to maximize recognition. They are handcrafted to fit the needs of the VSETH and to incorporate our brand values.



Guidance

We provide an icon set but you are open to choose to use a different icon set. In case you chose to use icons other than provided by us there are certain rules to follow:

- Outline icons should be used when possible
- The icons should stay in harmony with each other; don't pick icons with different styles
- The icons should stay consistent with the rest of the VSETH's branding guidelines
- The icons should be single-colored



Applications

The main application of icons in the VSETH is on websites. There, icons should always have the same color as the accompanying text/label.

You should be consistent with the icon usage. For example, if you choose to use icons in the navigation, give all the navigation links an icon.

Note that icons are not meant to replace text. They help finding things faster because the human perception is better at recognizing images than text. But if the icon's meaning is not clear enough, it can have the opposite effect. That is, only use icons as stand-alone if they are clear and meaningful, for example the gear wheel for settings or the magnifying glass for search.

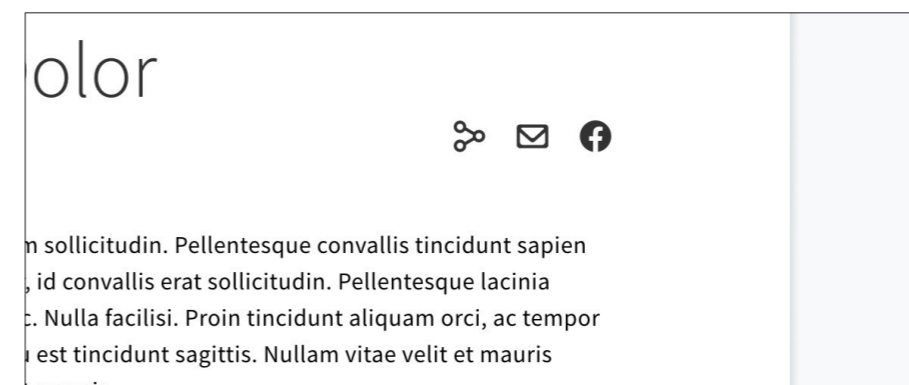
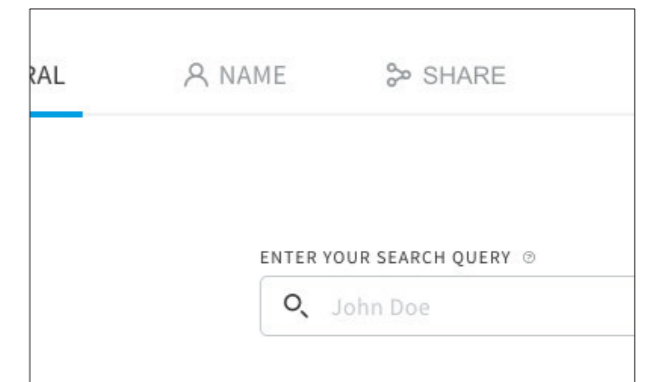
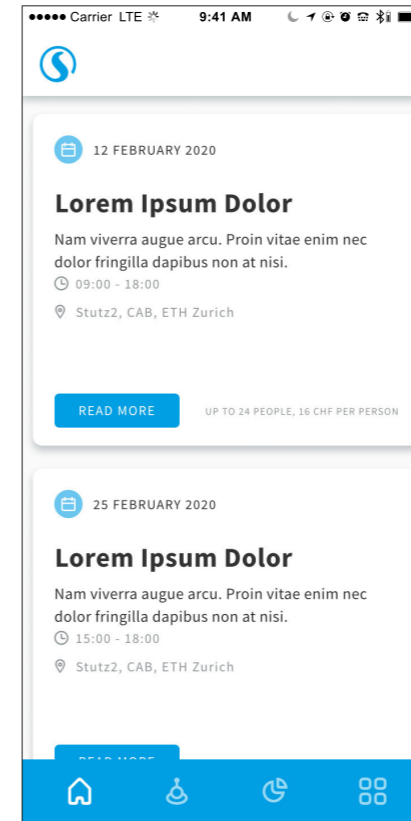

Illustration

Our illustration style is simple and consistent. Simple shapes, clean lines, and limited color give our illustration a branded feel, but also huge versatility and freedom among the illustration creators.

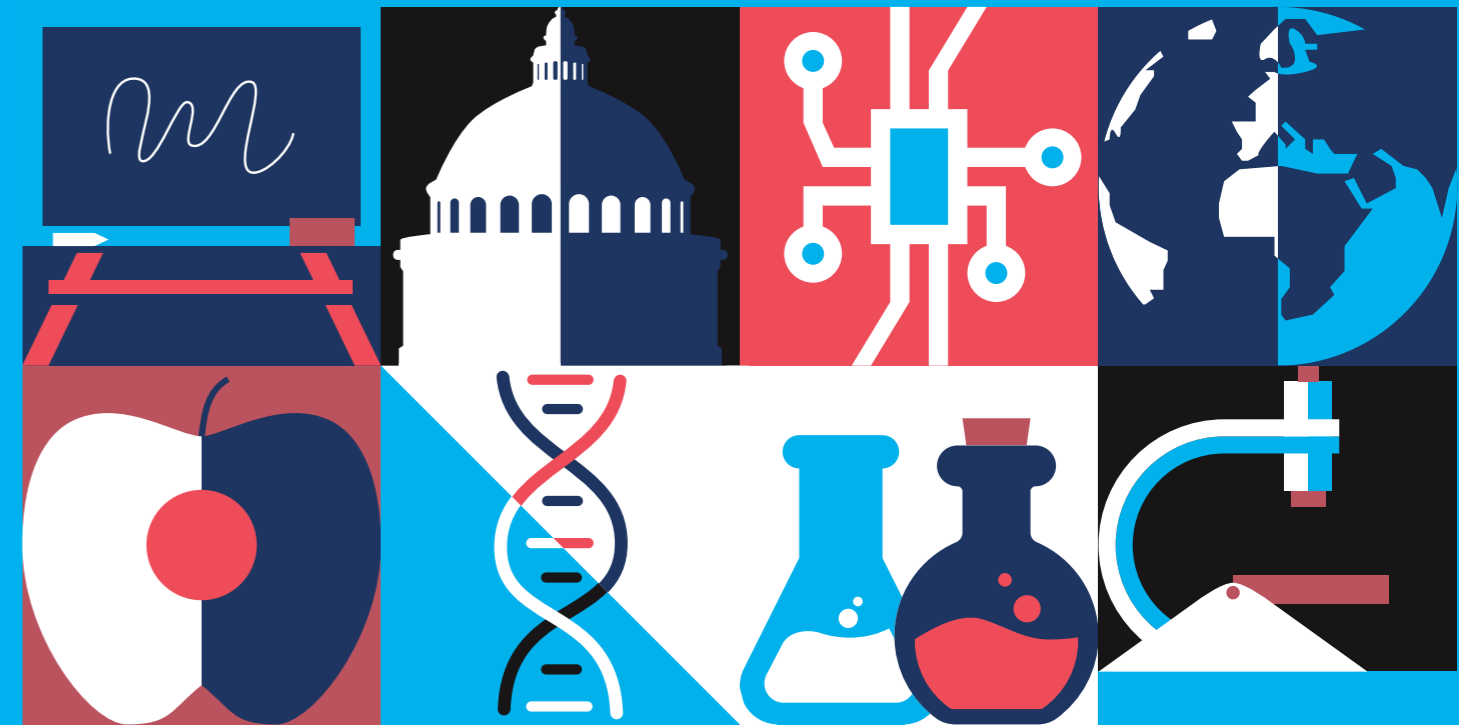

Principles

The principle of our illustrations is straight-forward: keep it simple, keep it clear. The illustrations should not be over-engineered. Often, the best result is the simplest one, so do more with less. Use simple shapes, clean lines, and try to use our limited color set as much as possible.

Our goal is not to enforce a rigorous guide for illustrations, but to build a connection between different illustrations and illustration styles. There are a few examples provided in this section.

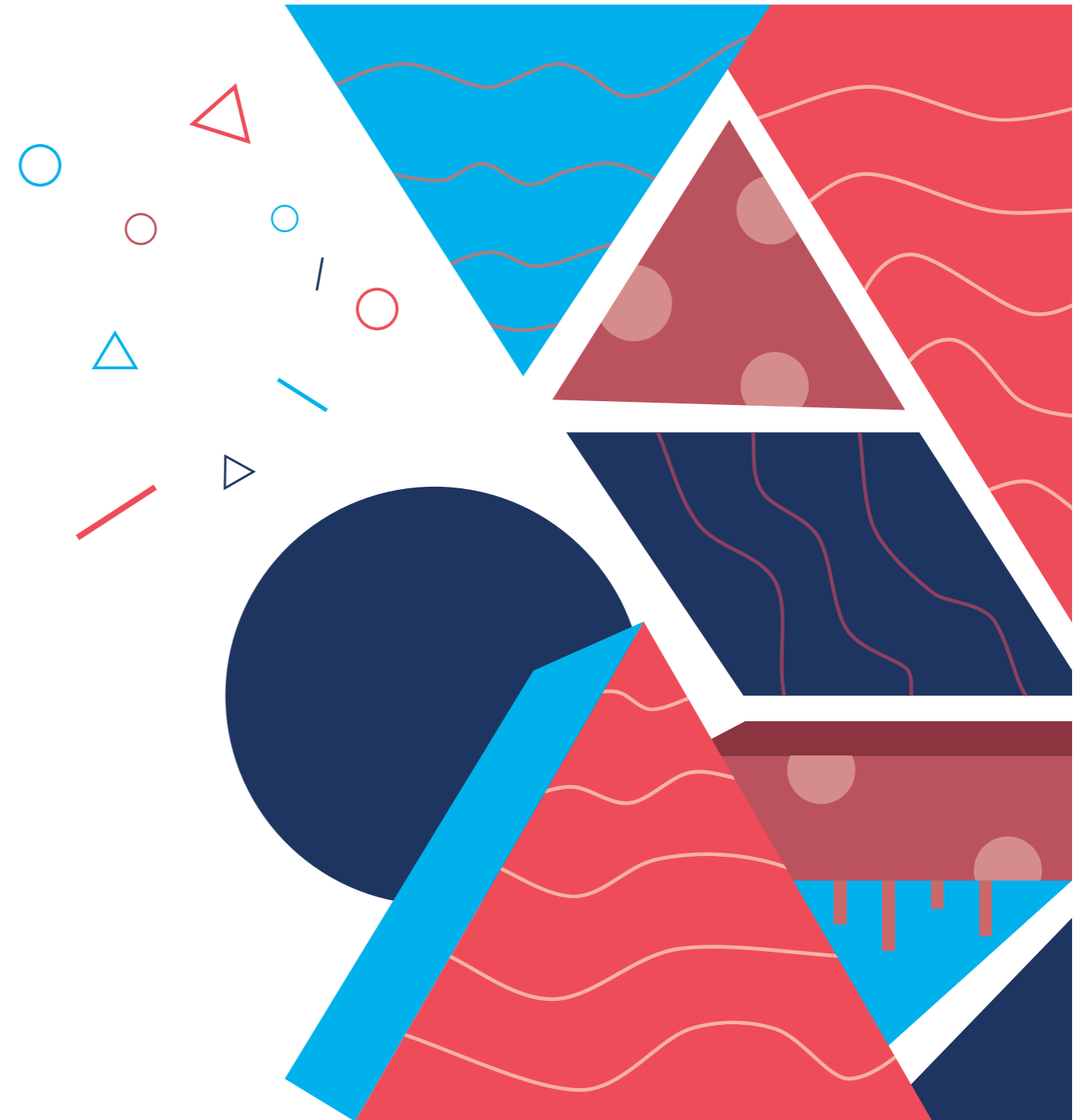

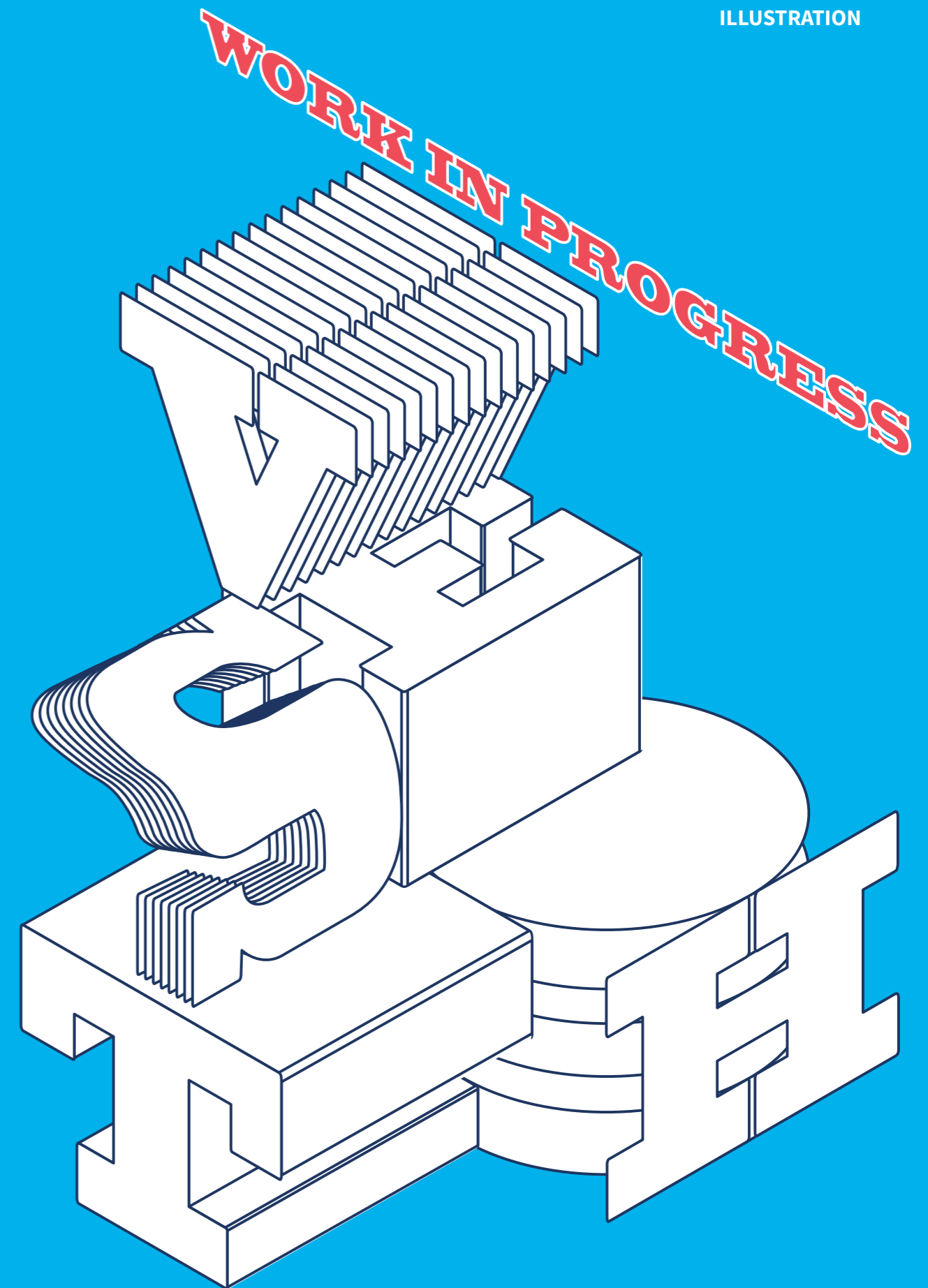

Photography

Our photography captures the VSETH as a whole. It connects the student body and the university in a similar way as the VSETH itself.

EXAMPLE

Overview

The photography of the VSETH should represent the VSETH itself. All photos used in context with the VSETH should represent its values and interests.

Feel free to get creative, but still hold true to the VSETH guidelines.

EXAMPLE

Interactions

The goal of our photos is to capture and showcase how the VSETH connects the students with other students and the university.

- Subjects are in lively moments full of energy and conveying a positive emotional impact
- Individuals or groups of people should feel 'caught in the moment' and unaware of the camera, as if the viewer is unobtrusively brought into an intimate moment
- Highlight how the VSETH brings people together with people and the university
- There should be no forced or posed-looking expressions or actions

EXAMPLE

Guidance

Things to avoid:

- Blown out areas, images need to hold tone on white; no overexposed skies etc.
- Cluttered and complex compositions that distract from the main hero
- Harsh shadows or lighting on the subject, along with reflections and blur that complicate the photo
- Forcing the talent to pose in unnatural ways, or express emotion that is not true to the narrative

EXAMPLE

